



# Opticare Instruments

SUPPLIERS OF MICRO OPHTHALMIC INSTRUMENTS



 PLOT# 116, STREE# 8, I-10/3 INDUSTRIAL  
AREA ISLAMABAD-44800, PAKISTAN

 +92 3435331290

 CONTACT@OPTICAREINSTRUMENTS.COM

FAX : +92 51 4437371





---

<b>Scissors Titanium and Stainless</b>	4-6
<hr/>	
<b>Forceps</b>	
Toothed and Tying, Titanium	7-8
Toothed and Tying, Stainless	12-14
Capsulorhexis, Titanium and Stainless	9-10
Nucleus Crackers, Titanium	9
Nucleus Crackers, Stainless	11-12
Pre-chopping, Titanium	11
Lens Insertion & Folding, Titanium and Stainless	9-10
Cilia, Jewelers, Stainless	14-15
Mosquito, Bi-Polar, Chalazion, Stainless	15-16
<hr/>	
<b>Needle Holders, Titanium and Stainless</b>	16-18
<hr/>	
<b>Fixation Rings, Titanium</b>	19
<hr/>	
<b>Spatulas and Hooks, Titanium and Stainless</b>	19-21
<hr/>	
<b>Retractors, Scleral Depressors, Lid Plates, Stainless</b>	21
<hr/>	
<b>Lens Loops, Spuds, Currettes, Stainless</b>	22
<hr/>	
<b>Lacrimal Probes, Muscle Hooks, Calipers, Stainless</b>	23
<hr/>	
<b>Serrefines, Punches, Stainless</b>	24
<hr/>	
<b>Lid Speculums, Titanium and Stainless</b>	24-25
<hr/>	
<b>Bi-Manual I/A Handpieces and Tips</b>	25
<hr/>	
<b>Foreign Body Kits, Sterilization Trays</b>	26
<hr/>	
<b>Vitreoretinal Scissors and Forceps</b>	27
<hr/>	
<b>Cannulas</b>	28-36
<hr/>	
<b>Disposable Ophthalmic Knives</b>	37
<hr/>	
<b>Surgery Sets</b>	38-50
<hr/>	





Scissors

Description/Item No. Length

**VANNAS CAPSULOTOMY SCISSORS**

8mm sharp blades.

- 1-110 Straight 3<sup>7</sup>/<sub>16</sub>" length
- 1-111 Curved 3<sup>7</sup>/<sub>16</sub>" length
- 1-112 Angled 3<sup>7</sup>/<sub>16</sub>" length



1-110



1-111



1-112

**WESTCOTT STRAIGHT SCISSORS**

20mm blades.

- 1-500 Straight, sharp 4<sup>1</sup>/<sub>2</sub>" length
- 1-501 Straight, blunt 4<sup>1</sup>/<sub>2</sub>" length



1-500

**McPHERSON/WESCOTT SCISSORS**

10mm blades.

- 1-505 Blunt 4" length
- 1-506 Sharp 4" length



1-505

**WESTCOTT CURVED SCISSORS**

20mm blades.

- 1-520 Blunt 4<sup>1</sup>/<sub>2</sub>" length
- 1-522 Blunt, left 4<sup>1</sup>/<sub>2</sub>" length



1-522

**FOLDABLE LENS REMOVING SCISSORS AND FORCEPS**

- 1-670 Scissors, stainless steel blades 4 <sup>7</sup>/<sub>16</sub>"



1-670

- 2-770 Forceps 4<sup>1</sup>/<sub>2</sub>" length



2-770



## Scissors Continued

Description/Item No. Length

### CASTROVIEJO CORNEAL SECTION SCISSORS

1-4360	Universal	4 <sup>1</sup> / <sub>2</sub> " length
1-4364	Standard 14mm, right	4 <sup>1</sup> / <sub>2</sub> " length
1-4365	Standard 14mm, left	4 <sup>1</sup> / <sub>2</sub> " length
1-4374	Miniature 13mm, right	4 <sup>1</sup> / <sub>2</sub> " length
1-4375	Miniature 13mm, left	4 <sup>1</sup> / <sub>2</sub> " length



1-4364



1-4374

### WESTCOTT SCISSORS

1-5122	Westcott Tenotomy, curved, blunt	4 <sup>1</sup> / <sub>2</sub> " length
1-5450	Westcott Tenotomy, curved, right	4 <sup>1</sup> / <sub>2</sub> " length
1-5500	Westcott stitch, standard	4 <sup>1</sup> / <sub>2</sub> " length



1-5450



1-5500

### TENOTOMY SCISSORS

1-7111	Stevens Tenotomy, straight, standard	4 <sup>1</sup> / <sub>2</sub> " length
1-7112	Stevens Tenotomy, curved, standard	4 <sup>1</sup> / <sub>2</sub> " length
1-7121	Stevens Tenotomy, ribbon type, straight, blunt	4" length
1-7122	Stevens Tenotomy, ribbon type, curved, blunt	4" length
1-7131	Straight eye scissors	4 <sup>1</sup> / <sub>2</sub> " length

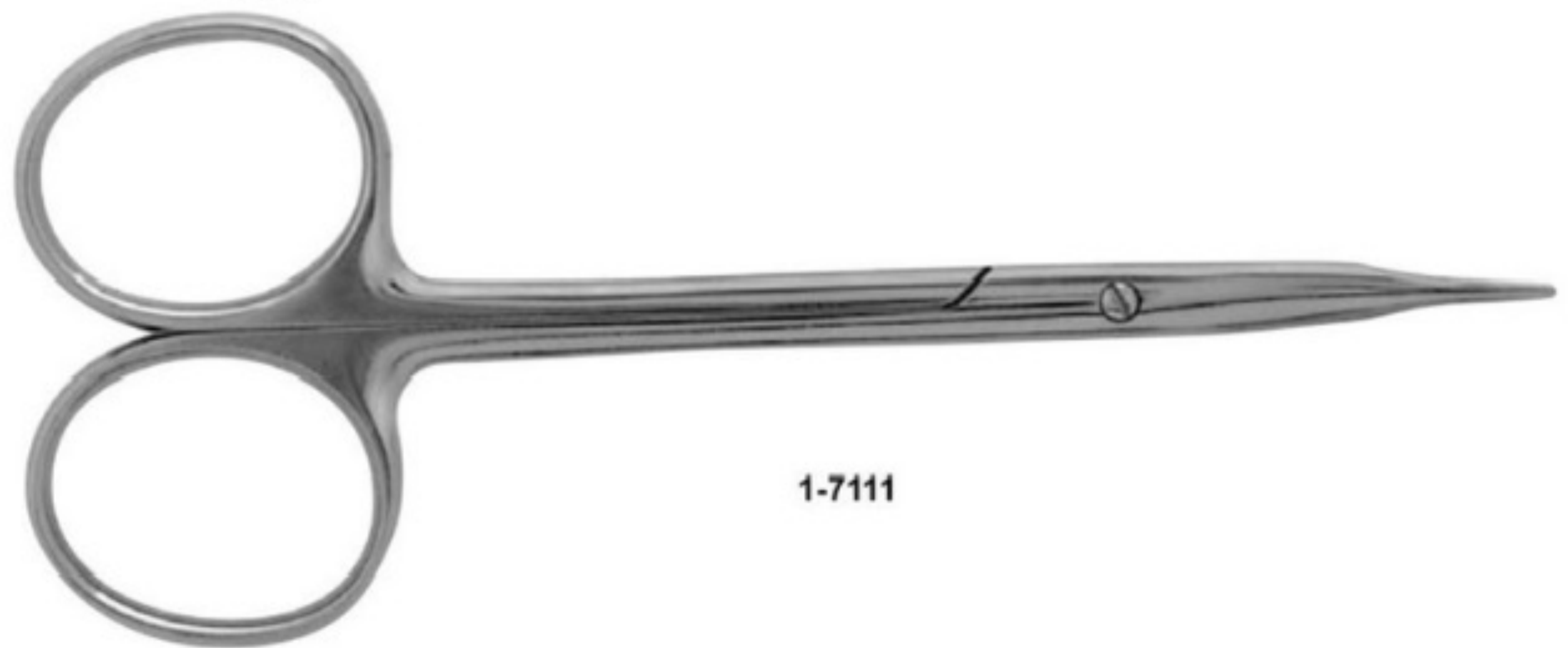

1-7111

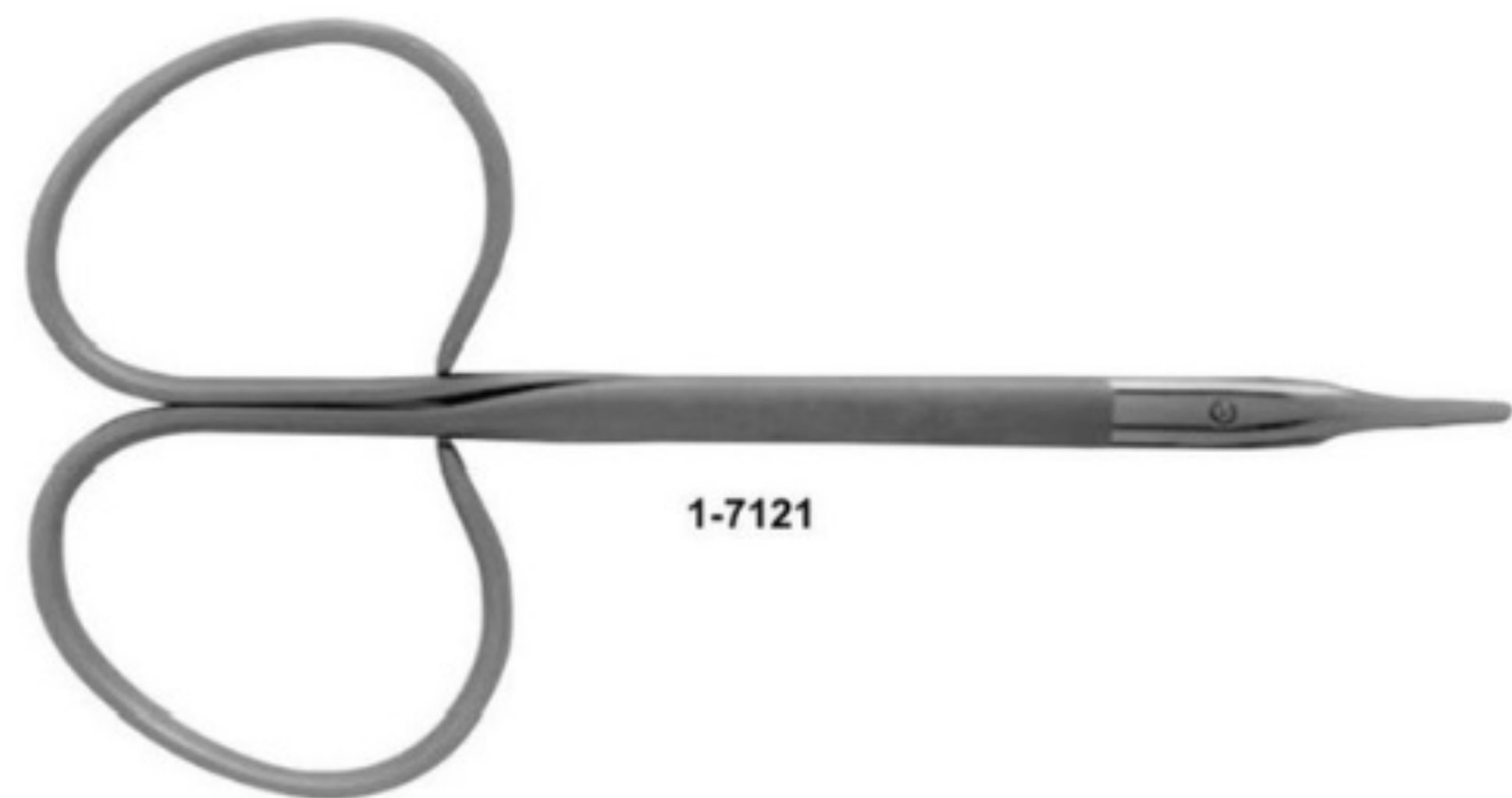

1-7121



1-7131



Scissors Continued

Description/Item No. Length

**VANNAS CAPSULOTOMY SCISSORS**

1-8031 Straight 3<sup>1</sup>/<sub>4</sub>" length  
 1-8032 Curved 3<sup>1</sup>/<sub>4</sub>" length  
 1-8033 Angled 3<sup>1</sup>/<sub>4</sub>" length



1-8031



1-8032



1-8033

**IRIS SCISSORS**

1-8054 Straight, ring handle 3<sup>7</sup>/<sub>8</sub>" length  
 1-8055 Curved, ring handle 3<sup>7</sup>/<sub>8</sub>" length

**GILLS-WELSH SCISSORS**

1-9011 11mm, angled blades 3<sup>1</sup>/<sub>4</sub>" length



1-9011

**FINE STITCH SCISSORS**

1-9531 13mm jaws 4<sup>1</sup>/<sub>4</sub>" length



1-9531



## Forceps

All forceps have laser-etched symbols corresponding to their tip configurations for easy identification. Our forceps and needle holders feature our 'TNT™', titanium-on-titanium gripping surface. This exclusive process creates a textured, but smooth surface, providing an unsurpassed grip without affecting suture or needle integrity.



PIERCE



TOOTHED



TYING



PLAIN

Description/Item No. Length

### STRAIGHT PIERSE FORCEPS

With tying platforms and 'TNT™' gripping surface.

2-100 3<sup>3</sup>/<sub>4</sub>" length  
2-104 4<sup>1</sup>/<sub>2</sub>" length



2-100

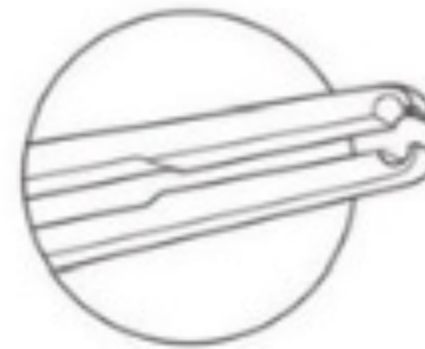

2-100  
2-104

### STRAIGHT TOOTHED FORCEPS

With tying platforms and 'TNT™' gripping surface.

2-110 .12mm, 1 x 2 teeth 3<sup>3</sup>/<sub>4</sub>" length  
2-114 .12mm, 1 x 2 teeth 4<sup>1</sup>/<sub>2</sub>" length  
2-118 .3mm, 1 x 2 teeth 3<sup>3</sup>/<sub>4</sub>" length

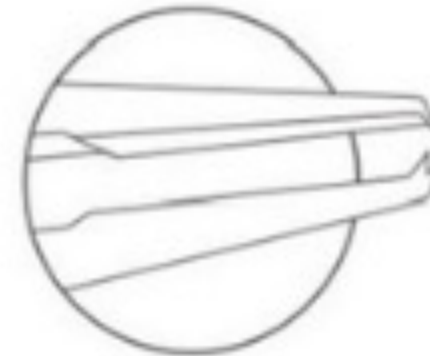

2-110  
2-114  
2-118

### STRAIGHT TYING FORCEPS

With tying platforms and 'TNT™' gripping surface.

2-500 3<sup>3</sup>/<sub>4</sub>" length  
2-504 4<sup>1</sup>/<sub>2</sub>" length



2-500  
2-504

### STRAIGHT PLAIN FORCEPS

Plain, no tying platforms, with 'TNT™' gripping surface.

2-900 3<sup>3</sup>/<sub>4</sub>" length

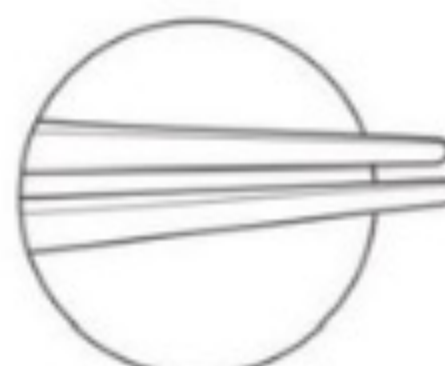

2-900

### CURVED PIERSE FORCEPS

With tying platforms and 'TNT™' gripping surface.

2-101 3<sup>3</sup>/<sub>4</sub>" length



2-101



### CURVED TOOTHED FORCEPS

With tying platforms and 'TNT™' gripping surface.

2-111 .12mm, 1 x 2 teeth 3<sup>3</sup>/<sub>4</sub>" length



2-111

### CURVED TYING FORCEPS

With tying platforms and 'TNT™' gripping surface.

2-501 3<sup>3</sup>/<sub>4</sub>" length  
2-505 4<sup>1</sup>/<sub>2</sub>" length



2-501  
2-505



Forceps Continued

Description/Item No. Length

**COLIBRI PIERSE FORCEPS**

With tying platforms and 'TNT'™ gripping surface.

2-130 3<sup>3</sup>/<sub>4</sub>" length



2-130



**COLIBRI TOOTHED FORCEPS**

With tying platforms and 'TNT'™ gripping surface.

2-132 .12mm, 1 x 2 teeth 3<sup>3</sup>/<sub>4</sub>" length

2-135 .12mm, 1 x 2 teeth 4<sup>1</sup>/<sub>2</sub>" length

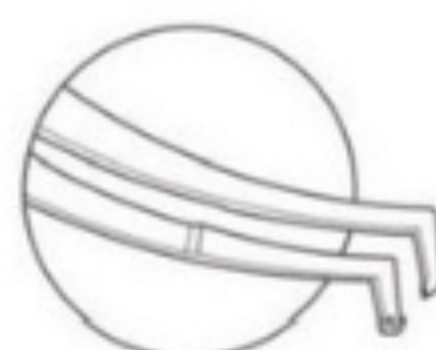

2-132  
2-135

**ANGLED TOOTHED FORCEPS**

With tying platforms and 'TNT'™ gripping surface, 12mm, 1 x 2 teeth.

2-142 McPherson, 7mm 3<sup>3</sup>/<sub>4</sub>" length

2-144 Kelman/McPherson, 10mm 3<sup>3</sup>/<sub>4</sub>" length

2-157 McPherson, 7mm 4<sup>1</sup>/<sub>2</sub>" length



2-142

**ANGLED TYING FORCEPS**

With tying platforms, and 'TNT'™ gripping surface.

2-520 Kratz, 5mm 3<sup>3</sup>/<sub>4</sub>" length

2-522 McPherson, 7mm 3<sup>3</sup>/<sub>4</sub>" length

2-524 Kelman/McPherson, 10mm 3<sup>3</sup>/<sub>4</sub>" length

2-526 Kelman/McPherson/ Sheets, 12mm 3<sup>3</sup>/<sub>4</sub>" length

2-527 McPherson, 7mm 4<sup>1</sup>/<sub>2</sub>" length

2-529 Kelman/McPherson, 10mm 4<sup>1</sup>/<sub>2</sub>" length



2-520  
2-522  
2-524  
2-526  
2-527  
2-529

**NORDAN STRAIGHT TYING FORCEPS**

Round handle with smooth, flattened surface for position reference, tying platforms with 'TNT'™ gripping surface.

2-410 4<sup>1</sup>/<sub>2</sub>" length



2-410



**NORDAN CURVED TYING FORCEPS**

Round handle with smooth, flattened surface for position reference, tying platforms with 'TNT'™ gripping surface.

2-420 4<sup>3</sup>/<sub>8</sub>" length



2-420

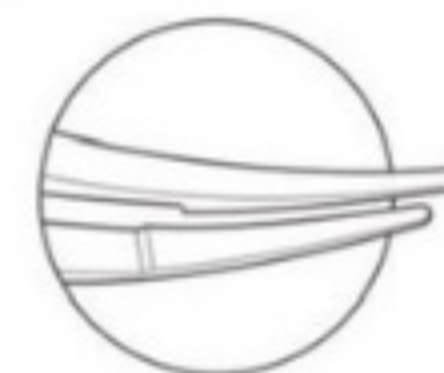

**NORDAN COLIBRI FORCEPS**

Round handle, 8mm diameter, smooth, flattened surface for position reference, tying platforms with 'TNT'™ gripping surface.

2-443 .12mm, 1 x 2 teeth 4<sup>3</sup>/<sub>8</sub>" length



2-443

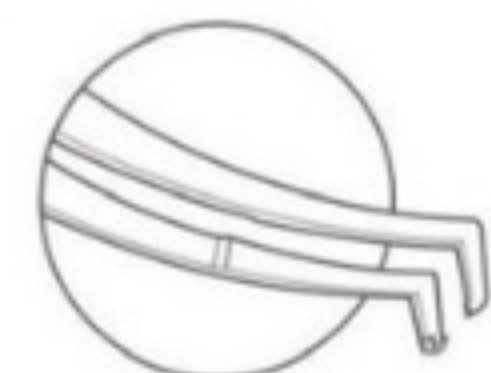



Forceps Continued

Description/Item No. Length

**NUCLEUS CRACKER**

Cross-action, 3mm paddles with outside cross serrations.

2-820

3" length

2-820



Lens Insertion Forceps

Description/Item No. Length

**ULTIMATE LENS INSERTION FORCEPS**

Designed to insert rolled and standard IOLs. Pierse-type tip grasps and tucks haptic without having to switch instruments.

2-780

4 1/2" length

2-780



**CROSS DIRECT FOLDABLE LENS INSERTION FORCEPS**

Combines ease of direct action with control of cross-action, with lock.

2-763

5 1/4" length

2-763



**DIRECT ACTION FOLDABLE LENS INSERTION FORCEPS**

Fine, straight jaws with lock.

2-764

4 5/8" length

2-764



**FOLDABLE LENS INSERTION FORCEPS, WIDE TIPS**

Straight jaws with wide tips for added stability and control, with lock.

2-767

4 5/8" length

2-767



**ROTHCHILD LENS FOLDING/INSERTION FORCEPS**

Cross-action jaws for slow, controlled release of lens.

2-768

4 3/4" length

2-768





**Foldable Lens Forceps**

Description/Item No. Length

**LENS HOLDING FORCEPS**

Highly polished, rounded angled jaws.

2-766 4<sup>3</sup>/<sub>8</sub>" length



2-766

**UNIVERSAL LENS FOLDER**

Folds all types of foldable lenses. Protective hood keeps lens from popping out.

2-4050 Stainless steel 4<sup>3</sup>/<sub>16</sub>" length



2-4050

**Capsulorhexis Forceps**

Description/Item No. Length

**BLOOMBERG CAPSULORHEXIS FORCEPS**

Flat handle with iris stop.

2-714 Curved jaw 3<sup>3</sup>/<sub>8</sub>" length

2-715 Straight jaw 3<sup>3</sup>/<sub>8</sub>" length



2-717

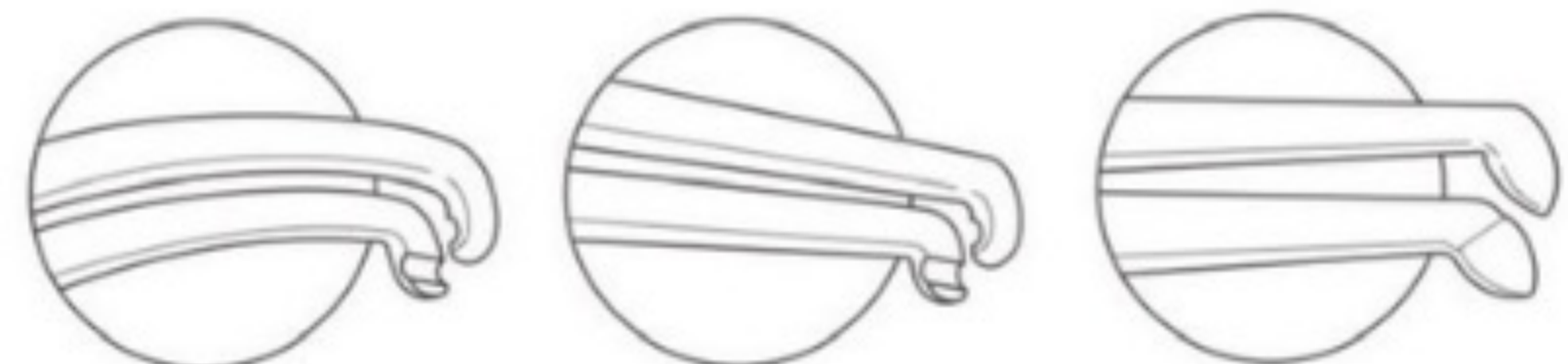

2-714

2-715

2-717

**UTRATA CAPSULORHEXIS FORCEPS**

Flat handle with iris stop.

2-717 Straight jaw 3<sup>3</sup>/<sub>8</sub>" length

**UTRATA CAPSULORHEXIS FORCEPS**

Round handle with iris stop.

2-707 Straight jaw 4<sup>3</sup>/<sub>4</sub>" length

2-712 Curved jaw 4<sup>3</sup>/<sub>4</sub>" length



2-707

**LONG CLEAR CORNEA CAPSULORHEXIS FORCEPS**

Unique curvature of jaws designed to perform a controlled capsulorhexis from the clear cornea incision without stretching the wound. Cystotome teeth with iris stop. Curved jaw.

2-709 4<sup>3</sup>/<sub>4</sub>" length



2-709

**NORDAN CAPSULORHEXIS FORCEPS**

Flattened surface along handle for position reference with iris stop. Straight jaw.

2-711 4<sup>3</sup>/<sub>4</sub>" length



2-711

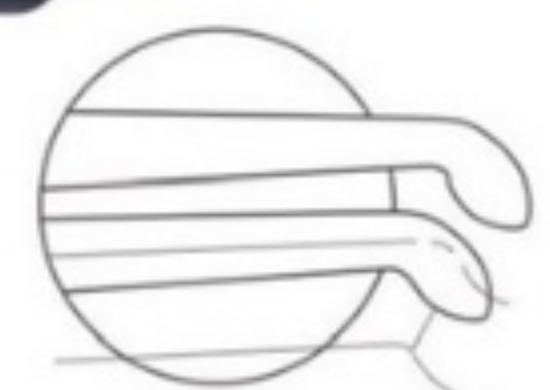



**Capsulorhexis Forceps Continued**

Description/Item No. Length

**NEVYAS CAPSULORHEXIS FORCEPS**

Cystotome teeth with iris stop.

2-713 Straight jaw 4<sup>3</sup>/<sub>4</sub>" length



2-716

**BLOOMBERG CAPSULORHEXIS FORCEPS**

Pierse teeth, with iris stop.

2-716 Straight jaw 4<sup>3</sup>/<sub>4</sub>" length

2-718 Curved jaw 4<sup>3</sup>/<sub>4</sub>" length

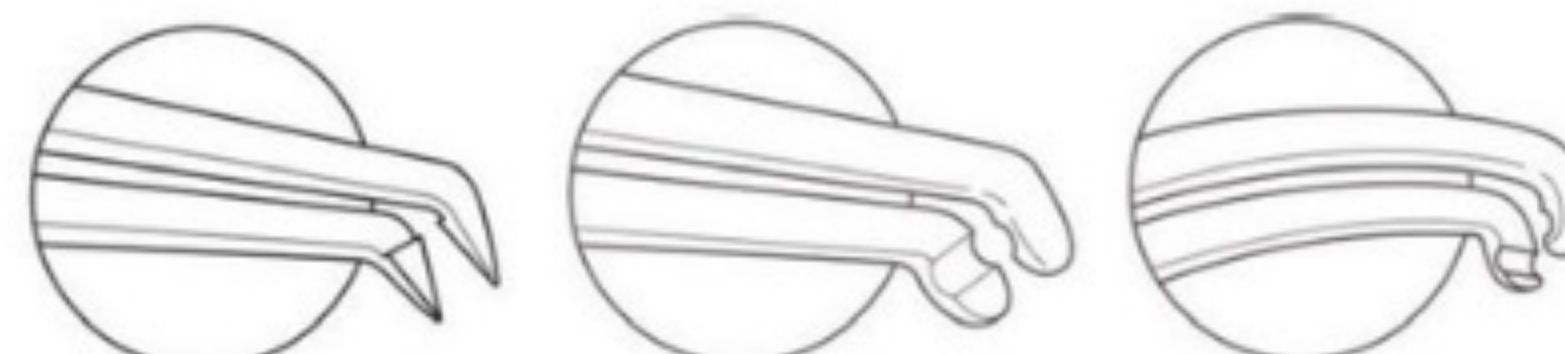

2-713

2-716

2-718

**TITANIUM PRECHOPPING FORCEPS**

Decreases phaco time by dividing the nucleus prior to phaco. Tips penetrate the nucleus while pressure on the cross-action handles divide the nucleus. Several tip designs available for different lens densities.

2-830 Straight, normal to hard density 4<sup>1</sup>/<sub>2</sub>" length

2-832 Angled, normal to hard density 4<sup>1</sup>/<sub>2</sub>" length

2-834 Curved, normal to hard density 4<sup>1</sup>/<sub>2</sub>" length

2-835 Universal, angled, any density 4<sup>1</sup>/<sub>2</sub>" length

2-836 Angled, soft density 4<sup>1</sup>/<sub>2</sub>" length

2-837 Combination, angled, soft to normal density 4<sup>1</sup>/<sub>2</sub>" length

2-838 Curved, soft density 4<sup>1</sup>/<sub>2</sub>" length



2-836

**Stainless Steel Forceps**

Description/Item No. Length

**CAPSULORHEXIS FORCEPS**

2-0900 Utrata, 12mm jaws, serrated handle 4<sup>3</sup>/<sub>4</sub>" length

2-0901 Kraff-Utrata, 12mm jaws 4<sup>3</sup>/<sub>4</sub>" length

2-0902 Nevyas, Cystotome tips 12mm jaws 4<sup>3</sup>/<sub>4</sub>" length

2-0905 Utrata, 20 ga, squeeze handle 4<sup>5</sup>/<sub>8</sub>" length



2-0901



2-0902



2-0905

**NUCLEUS CRACKER**

2-0930 2.5mm paddles 3" length



2-0930



## Forceps Continued

Description/Item No. Length

### DODICK NUCLEUS CRACKER

2-0931 2.5mm paddles 3" length



2-0931

### JAFFE TYING FORCEPS

With tying platforms.

2-1511 Straight 4" length  
2-1512 Curved 4" length



2-1511



2-1512

### TENNANT TYING FORCEPS

With tying platforms.

2-1521 Straight 3<sup>3</sup>/<sub>4</sub>" length  
2-1522 Curved 3<sup>3</sup>/<sub>4</sub>" length



2-1521



2-1522

### FINE TYING FORCEPS

With tying platforms.

2-1962 Curved 4 3<sup>1</sup>/<sub>16</sub>" length

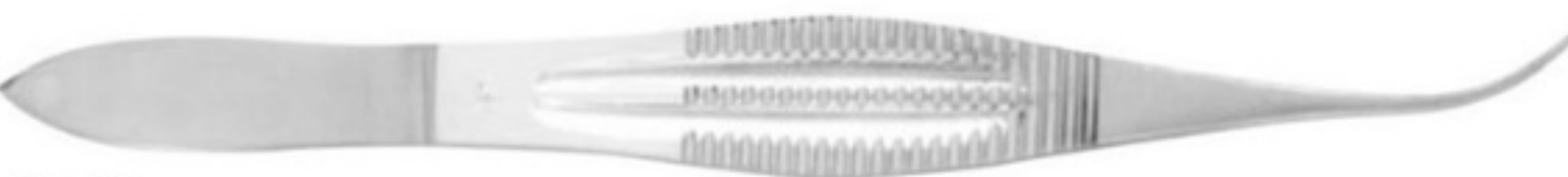

2-1962

### HARMS TYING FORCEPS

With tying platforms.

2-1951 Straight 4" length  
2-1952 Curved 4" length

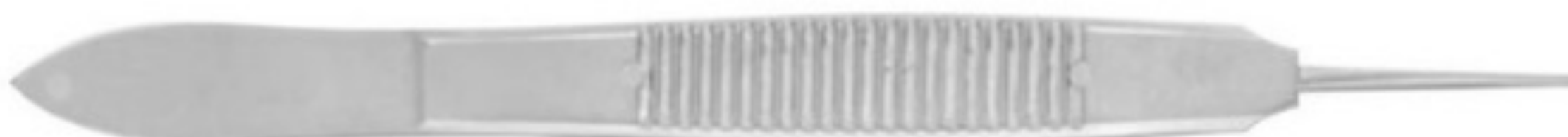

2-1951



2-1952

### MCPHERSON ANGLED TYING FORCEPS

With tying platforms.

2-1606 McPherson, 5mm angled jaw 3<sup>7</sup>/<sub>8</sub>" length  
2-1608 Kelman-McPherson, 8mm angled jaw 3<sup>7</sup>/<sub>8</sub>" length



2-1606

### MCPHERSON TYING FORCEPS

With tying platforms.

2-1671 Straight 3<sup>7</sup>/<sub>8</sub>" length



2-1671

### MCPHERSON TOOTHED FORCEPS

With tying platforms.

2-2612 Straight, 0.12mm, 1 x 2 teeth 3<sup>7</sup>/<sub>8</sub>" length



2-2612



Forceps Continued

Description/Item No. Length

**MCPHERSON ANGLED TOOTHED FORCEPS**

With tying platforms.

- 2-2617 5mm angled jaw, 0.12mm, 1 x 2 teeth 3<sup>7</sup>/<sub>16</sub>" length
- 2-2619 8mm angled jaw, 0.12mm, 1 x 2 teeth 3<sup>7</sup>/<sub>16</sub>" length



2-2617

**CASTROVIEJO TYING FORCEPS**

With tying platforms.

- 2-1201 Straight 4<sup>3</sup>/<sub>16</sub>" length

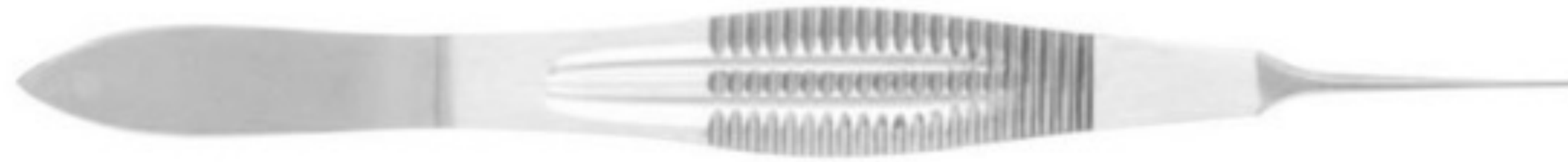

2-1201

**CASTROVIEJO SUTURING FORCEPS**

1 x 2 teeth with tying platforms.

- 2-2203 Straight, 0.3mm 4<sup>3</sup>/<sub>16</sub>" length
- 2-2205 Straight, 0.5mm 4<sup>3</sup>/<sub>16</sub>" length
- 2-2209 Straight, 0.9mm 4<sup>3</sup>/<sub>16</sub>" length
- 2-2212 Straight, 0.12mm 4<sup>3</sup>/<sub>16</sub>" length

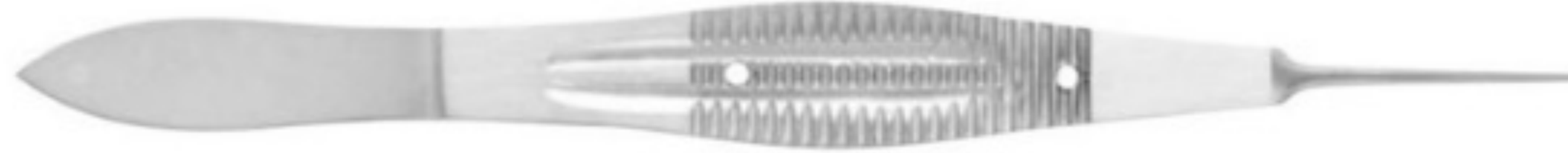

2-2203

**CASTROVIEJO SUTURING FORCEPS, STRAIGHT HANDLE**

1 x 2 teeth with tying platforms.

- 2-2222 Straight, 0.12mm 4<sup>3</sup>/<sub>16</sub>" length
- 2-2223 Straight, 0.3mm 4<sup>3</sup>/<sub>16</sub>" length
- 2-2225 Straight, 0.5mm 4<sup>3</sup>/<sub>16</sub>" length



2-2222

**STERN-CASTROVIEJO SUTURING FORCEPS**

1 x 2 teeth with tying platforms.

- 2-2217 0.5mm, with lock 4<sup>3</sup>/<sub>16</sub>" length



2-2217

**CASTROVIEJO ANGLED SUTURING FORCEPS**

1 x 2 teeth with tying platforms.

- 2-2232 7mm angled jaw, 0.12mm 4<sup>3</sup>/<sub>16</sub>" length
- 2-2233 7mm angled jaw, 0.3mm 4<sup>3</sup>/<sub>16</sub>" length



2-2233

**BONN STRAIGHT TOOTHED FORCEPS**

1 x 2 teeth with tying platforms.

- 2-2012 Short handle, 0.12mm 2<sup>7</sup>/<sub>16</sub>" length
- 2-2013 Long handle, 0.12mm 3<sup>3</sup>/<sub>4</sub>" length



2-2012

**TISSUE/FIXATION FORCEPS**

- 2-2508 Tissue forceps, straight, .8mm 3<sup>7</sup>/<sub>16</sub>" length
- 2-2242 Graefe fixation, 3.5mm 4<sup>1</sup>/<sub>4</sub>" length
- 2-2249 Manhattan Eye and Ear Fixation, .12mm, 1 x 2 teeth 3<sup>3</sup>/<sub>16</sub>" length



A2-2013



Forceps Continued

Description/Item No. Length

**LESTER FIXATION FORCEPS**

- 2-2512 0.6mm, 1 x 2 teeth 3<sup>9</sup>/<sub>16</sub>" length
- 2-2513 0.6mm, 2 x 3 teeth 3<sup>9</sup>/<sub>16</sub>" length



2-2512

**BISHOP HARMON STRAIGHT TISSUE FORCEPS**

- 2-2403 0.3mm, 1 x 2 teeth 4" length
- 2-2405 0.5mm, 1 x 2 teeth 4" length
- 2-2408 0.8mm, 1 x 2 teeth 4" length



2-2403

**COLIBRI FORCEPS**

- 2-2712 0.12mm, 1 x 2 teeth, without tying platforms 3" length
- 2-2714 0.12mm, 1 x 2 teeth, with tying platforms 3" length
- 2-2716 0.12mm, 1 x 2 teeth, with tying platforms, wide handle 4<sup>3</sup>/<sub>16</sub>" length
- 2-2718 Pierse type teeth, with tying platforms 4<sup>3</sup>/<sub>16</sub>" length



2-2712



2-2716

**TROUTMAN SUPERIOR RECTUS FORCEPS**

- 2-2809 10mm, angled jaws, 1 x 2 teeth 4<sup>3</sup>/<sub>16</sub>" length



2-2809

**BONACCOTTO UTILITY FORCEPS**

- 2-3460 1.2mm 4<sup>3</sup>/<sub>16</sub>" length



2-3460

**DRESSING FORCEPS**

Serrated.

- 2-3491 Straight, standard 4" length
- 2-3492 Curved, standard 4" length
- 2-3493 Straight, delicate 4" length
- 2-3494 Slight curve, delicate 4" length
- 2-3495 Strong curve, delicate 4" length



2-3493

**CILIA FORCEPS**

- 2-3614 3<sup>1</sup>/<sub>4</sub>" length
- 2-3616 Barraquer, slightly curved with tying platforms 3<sup>3</sup>/<sub>16</sub>" length



2-3614



Forceps Continued

Description/Item No. Length

**JEWELERS FORCEPS**

2-3010	#1	4 <sup>3</sup> / <sub>4</sub> " length
2-3030	#3	4 <sup>3</sup> / <sub>4</sub> " length
2-3030C	#3C	4 <sup>1</sup> / <sub>2</sub> " length
2-3040	#4	4 <sup>3</sup> / <sub>4</sub> " length
2-3050	#5	4 <sup>3</sup> / <sub>4</sub> " length
2-3070	#7	4 <sup>3</sup> / <sub>4</sub> " length



2-3010



2-3030



2-3030C



2-3040



2-3050



2-3070

**HARTMAN MOSQUITO FORCEPS**

2-7101	Straight	4" length
2-7102	Curved	4" length

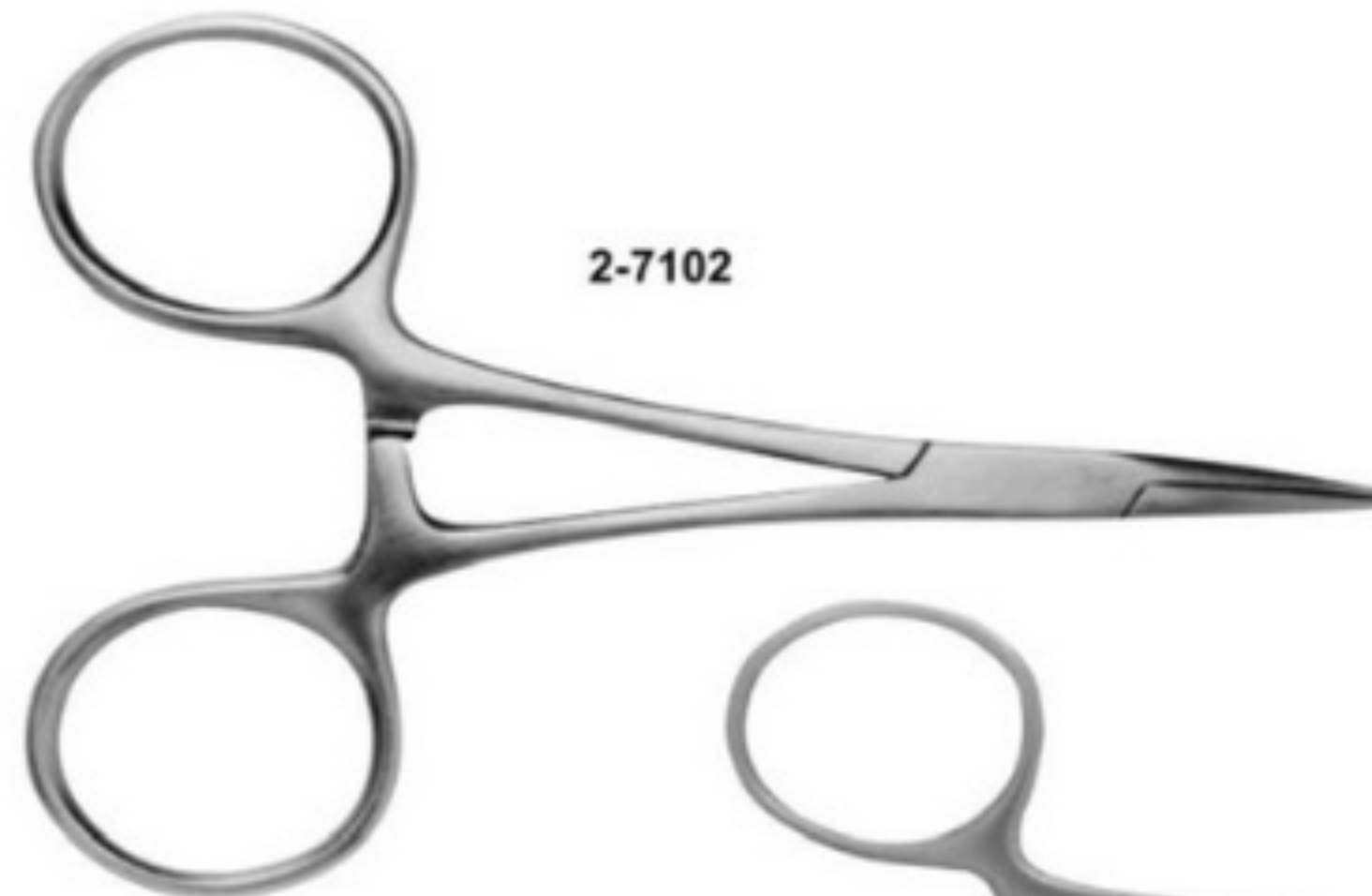

2-7102

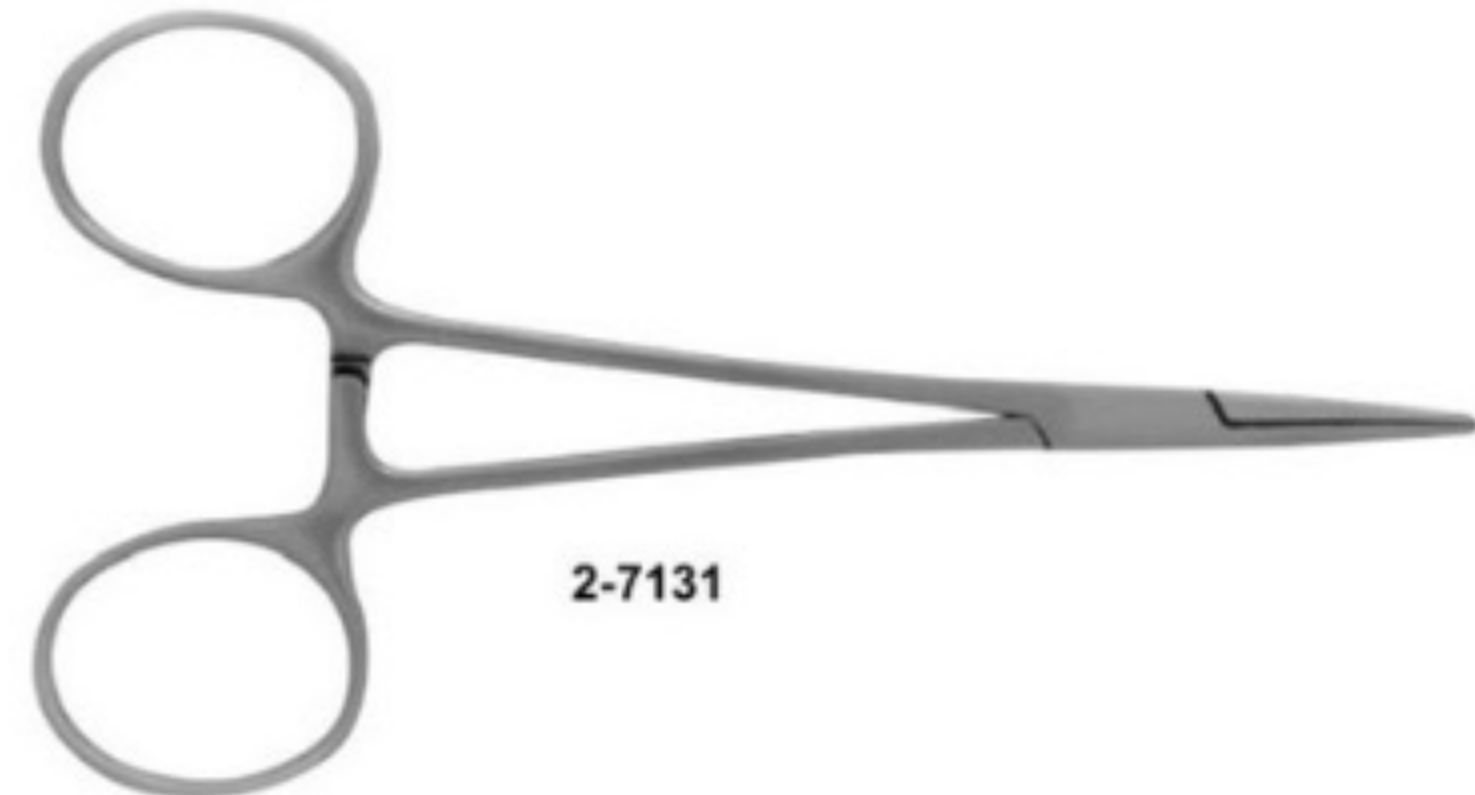

2-7131

**HALSTEAD MOSQUITO FORCEPS**

2-7131	Straight	5" length
2-7132	Curved	5" length

**BI-POLAR FORCEPS**

2-7950	McPherson bi-polar, angled	3 <sup>5</sup> / <sub>8</sub> " length
2-7951	Osher Coaptation bi-polar	4 <sup>5</sup> / <sub>8</sub> " length
2-7952	McPherson bi-polar, straight	3 <sup>3</sup> / <sub>4</sub> " length
2-7960	Adson bi-polar	5" length



2-7950



2-7951



## Stainless Steel Forceps

Description/Item No. Length

### BISHOP HARMON

Laser textured, 1 x 2 teeth.

2-2803	.3mm, laser textured	4" length
2-2805	.5mm, laser textured	4" length
2-2808	.8mm, laser textured	4" length



2-2803

### CHALAZION FORCEPS

2-7811	Baird, 8mm x 11mm	3 <sup>7</sup> / <sub>8</sub> " length
2-7814	Francis, 14mm x 12mm	3 <sup>7</sup> / <sub>8</sub> " length
2-7817	Wies, 12mm x 9mm	3 <sup>7</sup> / <sub>8</sub> " length
2-7818	Heath, 12mm x 14mm	3 <sup>3</sup> / <sub>4</sub> " length
2-7820	Desmarres, 13mm x 21mm	3 <sup>7</sup> / <sub>8</sub> " length
2-7821	Desmarres, 13mm x 15mm	3 <sup>3</sup> / <sub>4</sub> " length
2-7898	Lambert, 8mm x 8mm	3 <sup>3</sup> / <sub>4</sub> " length
2-7899	Lambert, 15mm ring	3 <sup>3</sup> / <sub>4</sub> " length



2-7811



2-7814



2-7817



2-7818



2-7820



2-7898

## Titanium Needle Holders

Our forceps and needle holders feature our 'TNT'™, titanium-on-titanium gripping surface. This exclusive process creates a textured, but smooth, surface providing an unsurpassed grip without affecting suture or needle integrity.

Description/Item No. Length

### BLUE MAX NEEDLE HOLDERS

Hinge pin closure for greater tip stability. Fine, delicate tips.

3-300	Straight, with lock	
3-301	Straight, without lock	
33-300	Straight, with lock	5 <sup>1</sup> / <sub>2</sub> " length
33-301	Straight, without lock	5 <sup>1</sup> / <sub>2</sub> " length
3-302	Curved, with lock	5 <sup>1</sup> / <sub>2</sub> " length
3-303	Curved, without lock	5 <sup>1</sup> / <sub>2</sub> " length
33-302	Curved, with lock	5 <sup>1</sup> / <sub>2</sub> " length
33-303	Curved, without lock	5 <sup>1</sup> / <sub>2</sub> " length



3-300



Titanium Needle Holders Continued

Description/Item No. Length

**NORDAN NEEDLE HOLDERS**

Hinge pin closure for greater tip stability.  
Fine, delicate curve.

3-420 Without lock 4<sup>3</sup>/<sub>4</sub>" length  
3-421 With lock 4<sup>3</sup>/<sub>4</sub>" length



**STRAIGHT NEEDLE HOLDERS  
EXTRA FINE JAWS**

3-200 With lock 4<sup>1</sup>/<sub>4</sub>" length  
3-201 Without lock 4<sup>1</sup>/<sub>4</sub>" length  
33-200 With lock 5<sup>1</sup>/<sub>4</sub>" length  
33-201 Without lock 5<sup>1</sup>/<sub>4</sub>" length



**STRAIGHT NEEDLE HOLDERS  
STANDARD JAWS**

3-220 With lock 4<sup>1</sup>/<sub>4</sub>" length  
3-221 Without lock 4<sup>1</sup>/<sub>4</sub>" length  
33-220 With lock 5<sup>1</sup>/<sub>4</sub>" length  
33-221 Without lock 5<sup>1</sup>/<sub>4</sub>" length

**CURVED NEEDLE HOLDERS  
EXTRA FINE JAWS**

3-202 With lock 4<sup>1</sup>/<sub>4</sub>" length  
3-203 Without lock 4<sup>1</sup>/<sub>4</sub>" length  
33-202 With lock 5<sup>1</sup>/<sub>4</sub>" length  
33-203 Without lock 5<sup>1</sup>/<sub>4</sub>" length



**CURVED NEEDLE HOLDERS  
STANDARD JAWS**

3-222 With lock 4<sup>1</sup>/<sub>4</sub>" length  
3-223 Without lock 4<sup>1</sup>/<sub>4</sub>" length  
33-222 With lock 5<sup>1</sup>/<sub>4</sub>" length  
33-223 Without lock 5<sup>1</sup>/<sub>4</sub>" length

**MICRO FINE NEEDLE HOLDERS**

Our finest tips.

3-210 Straight, without lock 4<sup>1</sup>/<sub>4</sub>" length  
3-211 Straight, with lock 4<sup>1</sup>/<sub>4</sub>" length  
3-212 Curved, without lock 4<sup>1</sup>/<sub>4</sub>" length  
3-213 Curved, with lock 4<sup>1</sup>/<sub>4</sub>" length



Stainless Steel Needle Holders

Description/Item No. Length

**CASTROVIEJO STANDARD  
STRAIGHT NEEDLE HOLDERS**

3-2010 Straight, without lock 5<sup>5</sup>/<sub>8</sub>" length  
3-2011 Straight, with lock 5<sup>5</sup>/<sub>8</sub>" length





## Needle Holders Continued

Description/Item No. Length

### CASTROVIEJO STANDARD

3-2020 Curved, without lock 5<sup>5</sup>/<sub>16</sub>" length  
 3-2021 Curved, with lock 5<sup>5</sup>/<sub>16</sub>" length



3-2020

### CASTROVIEJO DELICATE

3-2910 Straight, without lock 5<sup>5</sup>/<sub>16</sub>" length  
 3-2911 Straight, with lock 5<sup>5</sup>/<sub>16</sub>" length  
 3-2920 Curved, without lock 5<sup>5</sup>/<sub>16</sub>" length  
 3-2921 Curved, with lock 5<sup>5</sup>/<sub>16</sub>" length



3-2910



3-2920

### BARRAQUER TAPERED

3-4810 Straight, without lock 5<sup>1</sup>/<sub>4</sub>" length  
 3-4811 Straight, with lock 5<sup>1</sup>/<sub>4</sub>" length  
 3-4820 Curved, without lock 5<sup>1</sup>/<sub>4</sub>" length  
 3-4821 Curved, with lock 5<sup>1</sup>/<sub>4</sub>" length



3-4810

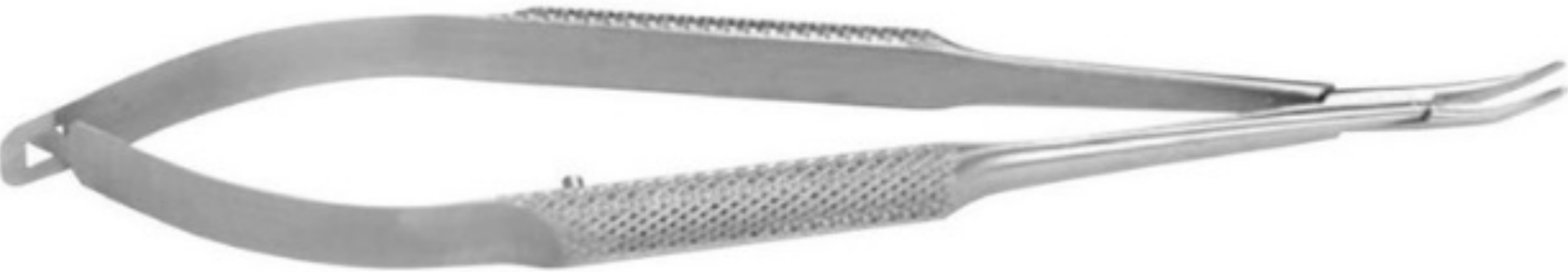

3-4821

### BARRAQUER DELICATE

3-4910 Straight, without lock 5<sup>1</sup>/<sub>4</sub>" length  
 3-4911 Straight, with lock 5<sup>1</sup>/<sub>4</sub>" length  
 3-4920 Curved, without lock 5<sup>1</sup>/<sub>4</sub>" length  
 3-4921 Curved, with lock 5<sup>1</sup>/<sub>4</sub>" length



3-4910

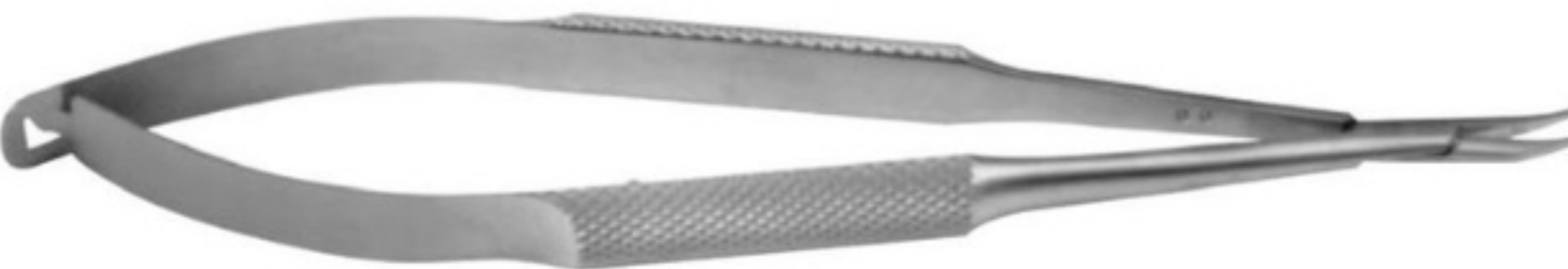

3-4920



## Fixation Rings

Description/Item No.

### THORNTON FIXATION RINGS

On swivel handle.

- 99-101  $\frac{3}{4}$ " ring, 13mm inner diameter  
 99-103  $\frac{3}{4}$ " ring, 16mm inner diameter



### FIXATION RINGS

- 99-102  $\frac{3}{4}$ " ring, concentric inner ring  
 99-104 Full circle, concentric inner ring  
 99-105 Offset swivel fixation ring  
 99-106 Full circle, 4 atraumatic teeth

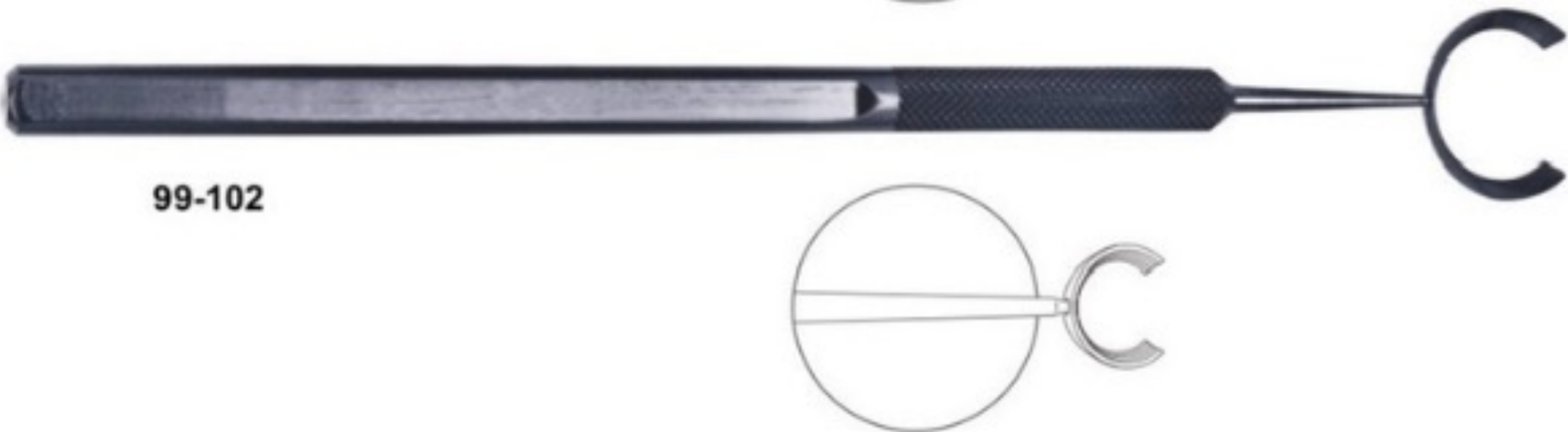

## Spatulas and Hooks

Description/Item No. Length

### SMOOTH LENS SPATULA

- 6-100 0.5mm wide  $4\frac{3}{4}$ " length



### NUCLEUS SUSTAINER

- 6-102  $4\frac{3}{4}$ " length



### BLOOMBERG NUCLEUS ROTATOR

- 6-103  $4\frac{3}{4}$ " length

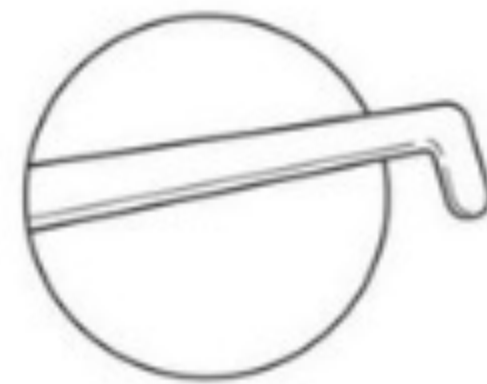

### BECHERT NUCLEUS ROTATORS

- 6-104 Horizontal tip  $4\frac{3}{4}$ " length  
 6-105 Vertical tip  $4\frac{3}{4}$ " length

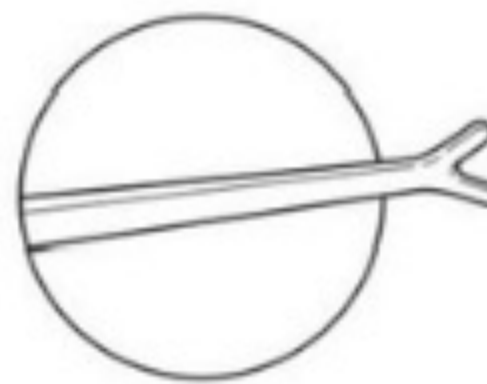

### KOCH NUCLEUS CHOPPER

With 45° offset cutting wedge, rounded tip.

- 6-106 Blunt tip  $4\frac{3}{4}$ " length

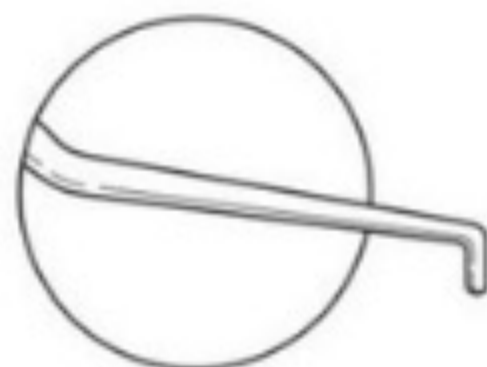

### NUCLEUS CHOPPERS

- 6-107 Cutting wedge  $4\frac{3}{4}$ " length  
 6-108 45° offset cutting wedge  $4\frac{3}{4}$ " length





Spatulas and Hooks Continued

Description/Item No. Length

**SINSKEY II HOOKS**

0.2mm diameter.

<b>6-250</b>	Angled, titanium	4 <sup>3</sup> / <sub>4</sub> " length
<b>6-2501</b>	Straight, stainless	4 <sup>3</sup> / <sub>4</sub> " length
	0.2mm diameter	
<b>6-250S</b>	Straight, titanium	4 <sup>3</sup> / <sub>4</sub> " length
<b>6-2502</b>	Angled, stainless	4 <sup>3</sup> / <sub>4</sub> " length
	0.2mm diameter	



6-250

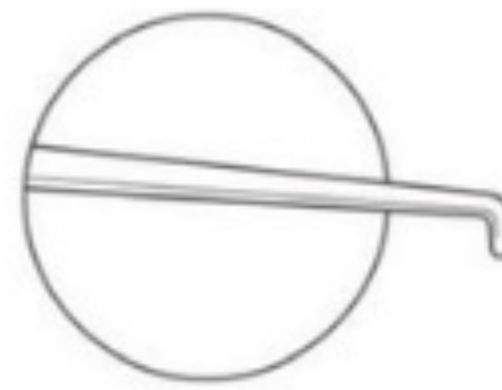

6-250S  
6-2501

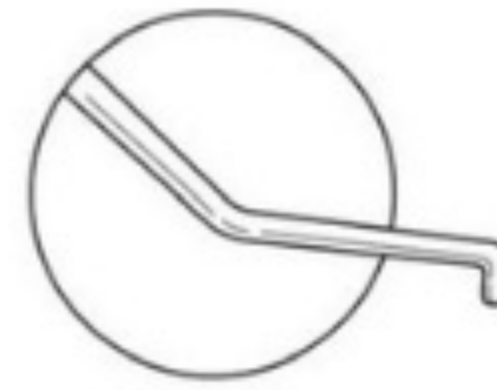

6-250  
6-2502

**MANIPULATORS**

Titanium.

<b>6-400</b>	Kuglen push/pull	4 <sup>3</sup> / <sub>4</sub> " length
<b>6-402</b>	Kuglen iris and lens hook	4 <sup>3</sup> / <sub>4</sub> " length
<b>6-450</b>	Lester angled push/pull	4 <sup>3</sup> / <sub>4</sub> " length
<b>6-460</b>	Hirschman push/pull	4 <sup>3</sup> / <sub>4</sub> " length
<b>6-500</b>	Fenzl lens	4 <sup>3</sup> / <sub>4</sub> " length



6-460

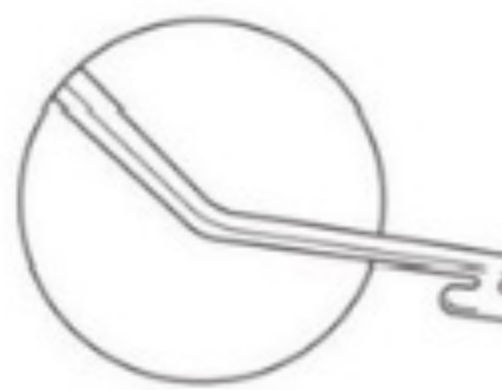

6-400



6-450



6-500



**BONN IRIS HOOK**

Stainless steel.

<b>6-1382</b>	Micro, angled	4 <sup>3</sup> / <sub>4</sub> " length
---------------	---------------	--



6-1382



**BARRAQUER IRIS SPATULAS**

Stainless steel.

<b>6-1425</b>	0.25mm	4 <sup>3</sup> / <sub>4</sub> " length
<b>6-1450</b>	0.50mm	4 <sup>3</sup> / <sub>4</sub> " length



6-1450

MS-110

**CYCLODIALYSIS SPATULAS**

Stainless steel. Castroviejo, double-ended.

<b>6-2025</b>	.25mm	5 <sup>5</sup> / <sub>16</sub> " length
<b>6-2050</b>	.5mm	5 <sup>5</sup> / <sub>16</sub> " length
<b>6-2075</b>	.75mm	5 <sup>5</sup> / <sub>16</sub> " length
<b>6-2001</b>	1.0mm	5 <sup>5</sup> / <sub>16</sub> " length



6-2025

**PATON DOUBLE-ENDED LENS SPATULA**

Stainless steel.

<b>6-2115</b>	Spoon, 6mm x 15mm with three grooves, spatula, 7mm angle, 2mm wide	5 <sup>1</sup> / <sub>4</sub> " length
---------------	--	--



6-2115

**KIMURA SPATULA**

Titanium handle, platinum tip.

<b>6-2117</b>	Angled	6" length
---------------	--------	-----------



6-2117



Spatulas and Hooks Continued

Description/Item No. Length

**BECHERT NUCLEUS ROTATOR**

6-3000 Angled 4<sup>31</sup>/<sub>64</sub>" length



**AKORN NUCLEUS CHOPPERS**

6-3001 Cutting wedge 4<sup>11</sup>/<sub>16</sub>" length  
6-3002 45° offset cutting wedge 4<sup>11</sup>/<sub>16</sub>" length



**SPHERICAL CHOPPERS**

6-3008 Angled 4<sup>31</sup>/<sub>64</sub>" length  
6-3009 Straight 4<sup>31</sup>/<sub>64</sub>" length  
6-109 Angled, titanium 4<sup>31</sup>/<sub>64</sub>" length



**DRYSDALE NUCLEUS ROTATOR**

6-3803 4<sup>11</sup>/<sub>16</sub>" length



Retractors

Description/Item No. Length

**DESMARRES LID RETRACTORS**

5-3400 #0, 11mm 5<sup>11</sup>/<sub>16</sub>" length  
5-3401 #1, 13mm 5<sup>11</sup>/<sub>16</sub>" length  
5-3402 #2, 15mm 5<sup>11</sup>/<sub>16</sub>" length  
5-3403 #3, 17mm 5<sup>11</sup>/<sub>16</sub>" length



Scleral Depressors

Description/Item No. Length

**SCLERAL DEPRESSORS**

5-4200 Thimble-type  
5-4202 Pen-type 4<sup>31</sup>/<sub>64</sub>" length  
5-4203 Schocket, double-ended 5<sup>31</sup>/<sub>64</sub>" length



Lid Plates

Description/Item No. Length

5-4242 Jaeger lid plate 4<sup>31</sup>/<sub>64</sub>" length  
5-4243 Jaeger lid plate, laser textured 4<sup>31</sup>/<sub>64</sub>" length





## Lens Loops

Description/Item No.	Length
<b>LENS LOOPS</b>	
6-5020 Curved, 3mm wide, serrated	5 1/4" length
6-5711 Kirby, 5mm x 10mm	5 1/4" length
6-5000 Lewis, small	5 1/4" length
6-5022 New Orleans, 5mm x 10mm	5 1/4" length



## Spuds/Collar Buttons

Description/Item No.	Length
<b>GOLF CLUB SPUD</b>	
6-6510 2mm blade, slightly rounded tip	4 3/4" length
<b>FOREIGN BODY SPUDS</b>	
6-6513 Davis, sharp, straight, rounded blade	4 3/4" length
6-6515 Ellis, curved, rounded blade	4 3/4" length
6-6517 Francis, squared-off, sharp tip	4 3/4" length
6-6519 Lance-shape, curved tip, titanium handle, stainless tip	4 3/4" length



6-6510



6-6513



6-6515



6-6519

## GRAETHER COLLAR BUTTONS

6-9641 Micro, straight	4 5/8" length
6-9642 Micro, angled	4 5/8" length



6-9641



## Curettes

Description/Item No.	Length
<b>MEYERHOEFER CHALAZION CURETTES</b>	
6-7000 #0, 1.5mm	5 1/4" length
6-7001 #1, 1.7mm	5 1/4" length
6-7002 #2, 2.2mm	5 1/4" length
6-7003 #3, 2.5mm	5 1/4" length
6-7004 #4, 3.0mm	5 1/4" length



6-7001



## Lacrimal Probes/Dilators

Description/Item No. Length

### BOWMAN LACRIMAL PROBES

Sterling silver, plain.

6-8000	#0000/000	5 <sup>11</sup> / <sub>16</sub> " length
6-8010	#00/0	5 <sup>11</sup> / <sub>16</sub> " length
6-8012	#1/2	5 <sup>11</sup> / <sub>16</sub> " length
6-8034	#3/4	5 <sup>11</sup> / <sub>16</sub> " length
6-8056	#5/6	5 <sup>11</sup> / <sub>16</sub> " length
6-8078	#7/8	5 <sup>11</sup> / <sub>16</sub> " length



6-8010

### CASTROVIEJO LACRIMAL DILATOR

6-8130	Double-ended	5 <sup>9</sup> / <sub>16</sub> " length
--------	--------------	---



6-8130

### WILDER LACRIMAL DILATOR

6-8131	#1, fine taper	4 <sup>1</sup> / <sub>2</sub> " length
6-8132	#2, medium taper	4 <sup>1</sup> / <sub>2</sub> " length
6-8133	#3, heavy taper	4 <sup>1</sup> / <sub>2</sub> " length



6-8131

### INFANT LACRIMAL DILATOR

6-8135	.5mm tip	3 <sup>1</sup> / <sub>4</sub> " length
--------	----------	--



6-8135

## Muscle Hooks

Description/Item No. Length

6-9100	Jameson, small, 8mm	5 <sup>3</sup> / <sub>16</sub> " length
6-9102	Jameson, large, 10mm	5 <sup>3</sup> / <sub>16</sub> " length
6-9105	Kirby hook and loop, double-ended	5 <sup>3</sup> / <sub>16</sub> " length
6-9107	Green muscle hook, small	5" length
6-9108	Stevens Tenotomy hook, small	4 <sup>3</sup> / <sub>4</sub> " length
6-9112	Von Grafe Tenotomy hook, #2	5 <sup>1</sup> / <sub>2</sub> " length
6-9115	Kennerdell Tenotomy hook, small	5" length



6-9102

## Calipers

Description/Item No. Length

7-2160	Castroviejo	3 <sup>3</sup> / <sub>4</sub> " length
7-2165	Jameson	4" length



7-2160



**Serrefines/Punches**

Description/Item No. Length

**DIEFFENBACH SERREFINES**

- 7-3401 Straight, small 1<sup>1</sup>/<sub>4</sub>" length
- 7-3402 Curved, small 1<sup>1</sup>/<sub>4</sub>" length
- 7-3406 Straight, large 2<sup>1</sup>/<sub>4</sub>" length
- 7-3407 Curved, large 2<sup>1</sup>/<sub>4</sub>" length

**PUNCHES**

- 7-5001 Kelley Decemet membrane punch
- 7-5003 Luntz-Dodick trabeculectomy punch
- 7-5005 Trabeculectomy punch with replaceable tips. Titanium body, stainless tips



7-5005

**Titanium Lid Speculums**

Description/Item No. Length

**WIRE LID SPECULUM, TEMPORAL**

For precise opening and control of lids.

- 99-120 Adult 3<sup>3</sup>/<sub>4</sub>" length
- 99-124 Infant 2<sup>1</sup>/<sub>4</sub>" length



99-120

**WIRE LID SPECULUM, NASAL**

- 99-122 Adult 2<sup>3</sup>/<sub>4</sub>" length
- 99-126 Infant 2<sup>1</sup>/<sub>4</sub>" length



99-123

**SOLID LID SPECULUM, TEMPORAL**

- 99-123 Adult 3<sup>3</sup>/<sub>4</sub>" length
- 99-127 Infant 2<sup>1</sup>/<sub>4</sub>" length



99-130

**SOLID LID SPECULUM, NASAL**

- 99-125 Adult 2<sup>3</sup>/<sub>4</sub>" length
- 99-129 Infant 2<sup>1</sup>/<sub>4</sub>" length

**ROTHCHILD LASIK LID SPECULUM**

Feature curved wire ends for patient comfort.

- 99-130 Temporal 3<sup>3</sup>/<sub>4</sub>" length



99-131

**ASPIRATING LID SPECULUM**

- 99-131 Temporal 3<sup>3</sup>/<sub>4</sub>" length
- 99-132 Nasal 3<sup>3</sup>/<sub>4</sub>" length

**REPLACEABLE LID SPECULUM SET**

- 99-134 3<sup>3</sup>/<sub>4</sub>" length



99-134



Lid Speculums Continued

Description/Item No. Length

**BARRAQUER WIRE LID SPECULUM**

5-2000 Adult, 14mm 1<sup>11</sup>/<sub>4</sub>" length  
 5-2010 Pediatric, 10mm 1<sup>3</sup>/<sub>4</sub>" length

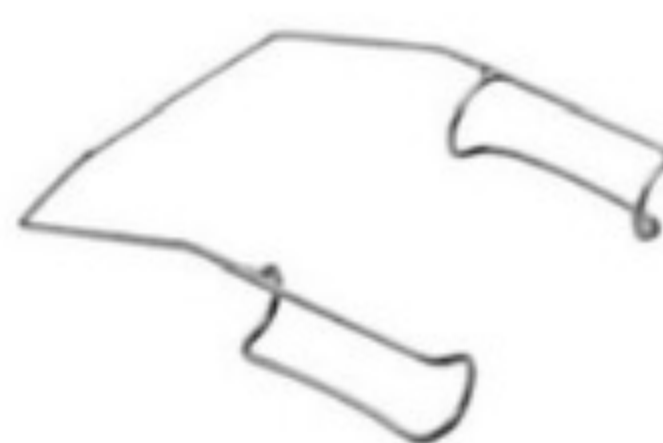

5-2000



5-2011

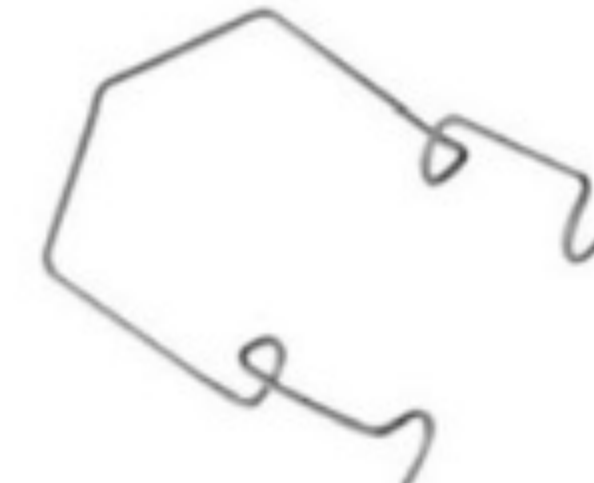

5-2017

**BARRAQUER SOLID LID SPECULUM**

5-2011 Pediatric, 11mm 1<sup>3</sup>/<sub>4</sub>" length  
 5-2015 Adult, 15mm 1<sup>1</sup>/<sub>4</sub>" length



5-2060

**KRATZ-BARRAQUER WIRE LID SPECULUM**

5-2017 Adult, 15mm 1<sup>1</sup>/<sub>4</sub>" length  
 5-2018 Pediatric, 11mm 1<sup>3</sup>/<sub>4</sub>" length



5-2065

**ADJUSTABLE LID SPECULUMS**

5-2060 Lieberman, temporal, V-blade 3<sup>3</sup>/<sub>4</sub>" length  
 5-2065 Lieberman, V-blade aspirating 3<sup>3</sup>/<sub>4</sub>" length  
 5-2403 Lancaster, solid, 15mm blades 2<sup>3</sup>/<sub>4</sub>" length  
 5-2404 Cook, adult 2<sup>3</sup>/<sub>4</sub>" length  
 5-2401 Cook, infant 2" length



5-2403



5-2404

Bloomberg Bi-Manual Irrigating/Aspirating Handpieces

Description/Item No.

**BI-MANUAL ASPIRATING HANDPIECES AND TIPS**

0-500 Curved, 21 ga, 0.3mm port  
 0-501 Aspirating handpiece only  
 0-502 Curved, 23 ga, 0.3mm port  
 0-503 Curved, 23 ga, 0.5mm port

**CURVED ASPIRATING TIPS ONLY**

0-510 21 ga, 0.3mm port  
 0-511 21 ga, 0.4mm port  
 0-512 21 ga, 0.3mm port, sand blasted  
 0-514 23 ga, 0.3mm port  
 0-516 23 ga, 0.3mm port, sand blasted  
 0-518 23 ga, 0.5mm port, sand blasted

**BI-MANUAL IRRIGATING HANDPIECES**

0-504 Irrigating handpiece only  
 0-505 Curved, 21 ga, 0.4mm dual ports  
 0-506 Curved, 21 ga, 0.5mm dual ports  
 0-507 Curved, 23 ga, 0.4mm dual ports  
 0-508 Curved, 23 ga, 0.5mm dual ports

**CURVED IRRIGATING TIPS ONLY**

0-520 21 ga, 0.4mm dual ports  
 0-522 21 ga, 0.4mm dual ports, sand blasted  
 0-524 23 ga, 0.4mm dual ports  
 0-526 23 ga, 0.4mm dual ports, sand blasted  
 0-527 23 ga, 0.5mm dual ports, sand blasted  
 0-528 21 ga, 0.5mm dual ports  
 0-529 21 ga, 0.5mm dual ports, sand blasted



0-500



0-505



0-505



0-500

**BLOOMBERG BI-MANUAL HANDPIECES**

- Aspiration tip can be maneuvered in any direction allowing cortical clean up in difficult to reach places.
- Separate handpieces allow irrigation stream to always be directed horizontally away from the endothelium.
- Exclusive, replaceable tips.
- Available with sandblasted tips for capsule polishing.
- Titanium handles, stainless steel tips.



Vitreoretinal Instruments



9-2402

Scissors

9-1100  
Straight scissors



9-1245 Angled  
microscissors, 135°



9-1111 Vertical  
Microscissors, 45°



9-1113 Vertical  
Microscissors, 80°



9-1200 Curved  
Microscissors



Forceps

9-2105  
Serrated jaw  
forceps



9-2304  
Foreign Body  
Grasper



9-2107  
Standard end  
gripping forceps



9-2350  
Sub-retinal angled  
forceps



9-2300  
Hockey stick  
forceps



9-2353  
Sub-retinal  
vertical  
microforceps



9-2302  
Pic



Tip Covers

9-9000 Protective tip cover for vitreoretinal scissors and forceps

9-9001 Protective tip cover for ILM forceps

ILM Forceps

9-2400  
Internal limiting  
membrane  
forceps,  
straight tip



9-2402  
Internal limiting  
membrane  
forceps, extra  
fine tip



INAMURA CAPSULORHEXIS FORCEPS

Inamura Capsulorhexis Forceps  
Incision down to 1.8mm

- Sharp pointed serrated interlocking tips
- Cross action tips, 1.5mm width at pivot box
- Straight shaft, tip to pivot point 9.5mm
- Marks on shaft 2.5mm and 5mm denote desired size of capsulorhexis
- Tips angled 45° from shaft
- Long round handle, overall length 110mm

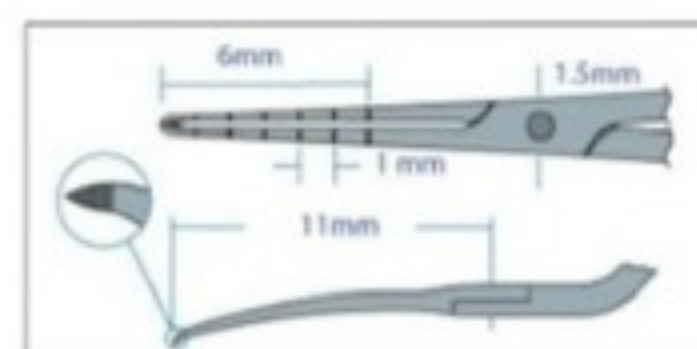



## NEEDLES - CYSTOTOMES - FLUSHING CANNULAS

- 4.3000** Retrobulbar  
needle, beveled,  
Ø 0.50 x 35 mm  
1 p.  
**4.3001** 12 p.  
**4.3011** Ø 0.50 x 50 mm  
12 p.



### FUKASAKU

- 4.3012** Sub-tenons  
pinpoint anesthesia  
cannula curved  
Ø 0.6 mm



- 4.3100** Cystotome  
cannula, curved  
Ø 0.4 mm  
**4.3101** Straight



- 4.3103** Irrigating cystotome formed  
Push-Pull Ø 0.40 x 13 mm  
8 mm bend to tip



- Ruby cystotome  
**4.3201** Angled, 25 g,  
Luer lock



### CHERIFI

- 4.3300** Flushing cannula,  
30 mm, angled,  
spatulated tip,  
Ø 0.6 mm  
**4.3301** Ø 0.8 mm





## ASPIRATING - AIR FLUID - HYDRODISSECTING CANNULAS

### HEALON

- 4.3302 Cannula, angled 10 mm from tip,  
Ø 0.5 mm, 20 mm.  
4.3303 Angled 11 mm,  
from tip, Ø 0.6 mm, 20 mm



- 4.3305 Air and fluid injection  
cannula, curved, very delicate, vertical  
flattened tip in the curve Ø 0.3 mm,  
4.3306 Ø 0.4 mm  
4.3314 Ø 0.5 mm  
4.3315 Ø 0.5 mm, horizontal flattened



### RYCROFT

- 4.3310 Air and fluid injection cannula,  
angled, Ø 0.3 mm  
4.3312 Ø 0.4 mm



### CALAMENDREI

- 4.3313 Air and fluid injection cannula,  
angled, Ø 0.5 mm



- 4.3315 Nucleus hydrodissecting cannula  
flattened tip Ø 0.5 mm, 22 mm



### MCINTYRE

- 4.3316 Nucleus hydrodissecting  
cannula, blunt tip  
Ø 0.3 mm, 17 mm



- 4.3317 Hydrodelineation cannula  
Parallel Beveled tip  
Ø 0.50 x 25 mm



### NICHAMIN

- 4.3318 Hydrodissecting cannula  
Ø 0.50 x 39 mm. Curved, flattened tip



### KELLAN

- 4.3319 Hydrodelineation cannula  
25 G, 20 mm beveled





## CYCLODIALYSIS - IRRIGATING - LASIK CANNULAS

### BARRAQUER

- 4.3323 Cyclodialysis cannula, angled, 3 ports: front, upper, lower



### BARRAQUER

- 4.3325 Alphachymotrypsine cannula, curved, olive tip



### BINKORST

- 4.3330 Irrigating cannula, straight, front port

- 4.3331 Right

- 4.3333 Left



### PEARCE

- 4.3340 Irrigating, vectis, 3 front ports

- 4.3341 1 front port 0.3 mm



### TERSON

- 4.3345 Air injection cannula, 18 mm, straight, olive tip, Ø 0.60 mm  
Port 0.35 mm



### BISHOP - HARMON

- 4.3350 A.C. Irrigator  
19 G W/bulb

- 4.3351 19 G irrigating cannula



- 4.3355 LASIK cannula to irrigate and lift the corneal flap  
Lower port



### VIDAURRI

- 4.3356 LASIK cannula, 8 irrigating ports  
Ø 0.50 mm, vertical

- 4.3357 Horizontal



- Air & fluid injection  
cannula, strong curve
- 4.3360 Ø 30 G (0.3 mm) L: 2 cm
- 4.3361 Ø 27 G (0.4 mm) L: 2 cm
- 4.3362 Ø 25 G (0.5 mm) L: 2 cm





## CORTEX EXTRACTOR - CAPSULE POLISHER

### SIMCOE

- 4.3400** Cortex extraction cannula, curved, side port facing into curve  
**4.3401** Side port reverse



### CHARLEUX

- 4.3404** Cortex extraction cannula  
 Ø 0.4 mm, L: 13 mm  
 curved, beveled end port  
**4.3405** Ø 0.6 mm, L: 13 mm  
**4.3406** Ø 0.6 mm, L: 20 mm



### ANIS

- Cortex aspiration cannula  
 Ø 0.6 mm, 0.4 mm  
 side port, sandblasted tip  
**4.3408** Straight  
**4.3409** Angled



### GALAND-BINKHORST

- Bent cannula for removal of subincisional cortex  
**4.3410** Right  
**4.3411** Left



- 4.3420** Capsule polisher, straight, side port 20 mm



### KRATZ

- 4.3424** Capsule polisher, olive tip, posterior abrasive tip, end port



### BLUMENTHAL

- 4.3427** Capsule polisher, straight, side port, Ø 0.6 mm, 28 mm  
**4.3428** Angled 1.5 mm from tip



### ANIS

- 4.3451** Lens manipulating cannula, olive shape, with notch, front port





**IRRIGATING CHOPPERS**

**AGARWAL**

**4.3470** Phakonit Irrigating chopper, front port  
Ø 0.95 mm



**CHANG**

**4.3471** Microfinger Irrigating chopper, front port  
For horizontal chopping  
Ø 0.95 mm



**DODICK**

**4.3472** Irrigating chopper  
Ø 0.6 mm dual side port  
Ø 0.95 mm



**ROSEN**

**4.3473** Irrigating chopper  
Shaped tip w/blunt end  
front port  
Ø 0.95 mm



**FUKASAKU**

**4.3474** Irrigating chopper  
w/front notch  
front port  
Ø 0.95 mm



**NAGAHARA**

**4.3476** Irrigating chopper  
60° angled  
Ø 0.95 mm





## IRRIGATION - ASPIRATION CANNULAS

### MACINTYRE

- 4.3500 I/A coaxial  
cannula, straight,  
side aspiration  
port, Ø 0.3 mm
- 4.3501 Front port



### MACINTYRE

- 4.3511 SFO I/A coaxial  
cannula, curved,  
side aspiration  
port, Ø 0.3 mm
- 4.3512 Side aspiration  
port, Ø 0.4 mm



### CHARLEUX

- 4.3520 I/A coaxial  
cannula, curved,  
aspiration front  
port angled at  
45°, Ø 0.4 mm



### MACINTYRE - CHARLEUX

- 4.3522 I/A coaxial  
cannula, inner  
cannula angled,  
side port,  
Ø 0.3 mm
- 4.3523 Side port,  
Ø 0.4 mm



### SIMCOE

- 4.3530 I/A cannula, side  
aspiration through  
tubing, Ø 0.3 mm,  
shorter end  
irrigation through  
Luer hub
- 4.3531 Aspiration  
Ø 0.4 mm





**IRRIGATION - ASPIRATION CANNULAS**

**SIMCOE**

**4.3535** I/A reversed cannula, side aspiration through Luer lock, Ø 0.3 mm shorter end irrigation through tubing



**4.3536** Aspiration Ø 0.4 mm

**GALAND**

**4.3540** I/A cannula, hook shape, side by side front ports, Ø 0.4 mm



**4.3541** I/A cannula, straight, side by side front ports, Ø 0.4 mm

Silicone tubing for I/A cannulas

**4.3550** Tubing with adaptor, 30 cm

**4.3551** Tubing only, 30 cm



**HESLIN - LEWICKI**

**4.3555** Chamber maintainer 23 G, threaded tip





## BI - MANUAL CANNULAS

**4.3567** Bi-manual aspiration  
Titanium hand piece  
23 G, 0.3 mm upper port  
Violet



**4.3564** Bi-manual aspiration  
Polishing  
Titanium hand piece  
23 G, 0.3 mm upper port  
Violet



**4.3568** Bi-manual irrigation  
Titanium hand piece  
23 G, 0.3 mm dual port  
Blue





**HAND PIECE - SYRINGES - LACRIMAL CANNULAS**

**MACINTYRE**

4.3600 Irrigation hand piece, teflon



4.3601 Infusion hand piece, teflon, 7.5 cm



4.3602 10 cm

4.3620 Glass syringe, Luer lock, 1 cc



4.3621 3 cc      4.3623 2 cc  
4.3622 5 cc      4.3624 10 cc

4.3626 20 cc

**BANGERTER**

4.3700 Lacrimal cannula, Ø 0.7 mm, L: 65 mm



4.3701 Ø 0.8 mm, L: 65 mm

4.3708 Ø 0.6 mm, L: 65 mm

**GALEZOWSKI**

4.3702 Lacrimal cannula, straight, fine, blunt, Ø 0.6 mm



4.3703 Curved

**TERSON PAUFIQUE**

4.3704 Lacrimal cannula, straight, fine, olive Tip, Ø 0.6 mm, 2 cm



**ANEL**

4.3705 Silver lacrimal cannula, straight, conical



**GALEZOWSKI**

4.3706 Lacrimal cannula straight, fine, Ø 0.3 mm, 0.9 cm



4.3709 Ø 0.4 mm, 2.0 cm

4.3707 Lacrimal cannula straight, blunt Ø 0.6 mm, 2 cm





## KERATOME BLADES

FOR ENTRY INTO ANTERIOR CHAMBER OR PHACO STAB INCISION

### SINGLE BEVEL

Product No.	Description	Gauge
K-11520	1.5 MM Sharp Tip Angled 45 Degree	20
K-11820	1.8 MM Sharp Tip Angled 45 Degree	20
K-12020	2.0 MM Sharp Tip Angled 45 Degree	20
K-12220	2.2 MM Sharp Tip Angled 45 Degree	20
K-12320	2.3 MM Sharp Tip Angled 45 Degree	20
K-12420	2.4 MM Sharp Tip Angled 45 Degree	20
K-12520	2.5 MM Sharp Tip Angled 45 Degree	20
K-126520	2.65 MM Sharp Tip Angled 45 Degree	20
K-127520	2.75 MM Sharp Tip Angled 45 Degree	20
K-12820	2.8 MM Sharp Tip Angled 45 Degree	20
K-13019	3.0 MM Sharp Tip Angled 45 Degree	19
K-13219	3.2 MM Sharp Tip Angled 45 Degree	19
K-13519	3.5 MM Sharp Tip Angled 45 Degree	19



### DOUBLE BEVEL

K-12819-2	2.8 MM Sharp Tip Angled 45 Degree	19
K-13019-2	3.0 MM Sharp Tip Angled 45 Degree	19
K-13219-2	3.2 MM Sharp Tip Angled 45 Degree	19

## ENLARGER BLADES

FOR ENLARGEMENT OF SLIT OR I.O.L. IMPLANT INCISION

Product No.	Description	Gauge
K-22819	2.8 MM Blunt Tip Angled 45 Degree	19
K-23019	3.0 MM Blunt Tip Angled 45 Degree	19
K-23218	3.2 MM Blunt Tip Angled 45 Degree	18
K-23518	3.5 MM Blunt Tip Angled 45 Degree	18
K-23818	3.8 MM Blunt Tip Angled 45 Degree	18
K-24016	4.0 MM Blunt Tip Angled 45 Degree	16
K-25116	5.1 MM Blunt Tip Angled 45 Degree	16
K-25516	5.5 MM Blunt Tip Angled 45 Degree	16
K-26015	6.0 MM Blunt Tip Angled 45 Degree	15
K-26215	6.2 MM Blunt Tip Angled 45 Degree	15



## CRESCENT BLADES

FOR GROOVE OR POCKET OR TUNNEL INCISION

### SINGLE BEVEL

Product No.	Description	Gauge
K-30020-U	Crescent Bevel Up Angled 45 Degree	20
K-30020-D	Crescent Bevel Down Angled 45 Degree	20

### DOUBLE BEVEL

K-30019-2	Crescent Angled 45 Degree	19
-----------	---------------------------	----



## LANCE TIP BLADES

FOR MAKING SIDE PORT OR FIRST SCLERAL INCISION

### SINGLE BEVEL

Product No.	Description	Gauge
K-41524	15 Degree	24
K-42224	22 Degree	24
K-43024	30 Degree	24
K-44524	45 Degree	24



## MVR BLADES

FOR WATER TIGHT SELF SEALING INCISION

Product No.	Description	Gauge
K-00523	MVR	23
K-00524	MVR	24
K-00522	MVR	22
K-00520	MVR	20
K-00519	MVR	19



**KERATOME BLADES**

FOR ENTRY INTO ANTERIOR CHAMBER OR PHACO STAB INCISION

**ENLARGER BLADES**

FOR ENLARGEMENT OF SLIT OR I.O.L. IMPLANT INCISION

**CRESCENT BLADES**

FOR GROOVE OR POCKET OR TUNNEL INCISION

**LANCE TIP BLADES**

FOR MAKING SIDE PORT OR FIRST SCLERAL INCISION